



### Features

- AT-Cut Crystal
- Surface Mount FR4 based package
- Low Phase Noise & Jitter
- Low G-Sensitivity
- Tight Stabilities
- Frequency Range 30 - 180MHz
- Standard Frequencies 50; 80; 100; 120; 122,88; 160MHz

### Applications

- Communication
- Industrial
- Test & Measurement
- Harsh Environment
- Military

### Performance Specifications

Frequency Stabilities <sup>1</sup>					
Parameter	Min	Typical	Max	Units	Condition
vs. operating temperature range (referenced to +25°C)	-25		+25	ppm	-40 to +85°C
Initial tolerance	-10		+10	ppm	@V <sub>c</sub> =V <sub>s</sub> /2
vs. supply voltage change	-3		+3	ppm	V <sub>s</sub> ±5%
vs. load change	-1		+1	ppm	Load ±10%
vs. aging (15 years)	-7		+7	ppm	

# Performance Specifications

Supply Voltage (Vs)						
Parameter	Min	Typical	Max	Units	Condition	
Supply voltage (standard)	3.135	3.3	3.465	VDC	Options	
Current consumption			20	mA		@ LVCMOS
Supply voltage	4.75	5	5.25	VDC		
Current consumption			15	mA		@ HCMOS
RF Output						
Signal	HCMOS					
Load		15		pF		
Rise and Fall time			5	ns	@ 15 pF 10 to 90%	
Duty cycle	45		55	%	@ Vs / 2	
Additional Parameters						
Phase Noise		-90		dBc/Hz	10 Hz	@120 MHz LVCMOS 3.3V
		-121		dBc/Hz	100 Hz	
		-147		dBc/Hz	1 kHz	
		-158		dBc/Hz	10 kHz	
		-165		dBc/Hz	100 kHz	
		-168		dBc/Hz	1 MHz	
		-168		dBc/Hz	10 MHz	
Jitter		32		fs RMS	@ 12kHz .. 20MHz	
G-Sensitivity		0.3		ppb/g	@0.06g <sup>2</sup> /Hz	
Weight			2.0	g		
Processing & Packing	Handling & Processing Note					
Absolute Maximum Ratings						
Supply voltage (Vs)			6.0	V		
Operable Temperature Range	-40		+85	°C		
Storage Temperature Range	-40		+105	°C		

# Standard Shipping Method

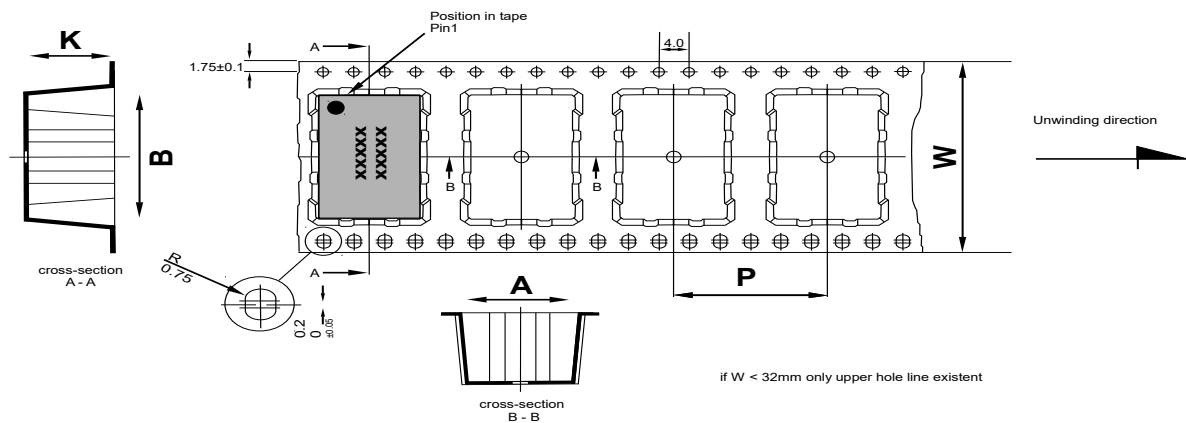

Dimension in mm:

A, B and K are dependent upon component dimensions  
production tolerance complying DIN IEC 286-3

All dimensions in millimeters unless otherwise stated

Enclosure Type	Tape Width W (mm)	Quantity per meter	Quantity per reel	Dimension P
G218C	24	83.3	1700	12

# Enclosure

## Package Codes

Type	Height "H"	Pin Length "L"
G218C	2.8	NA

## Pin Connections

1	N.C.
2	N.C. / Enable (Option)
3	Ground
4	RF Output
5	N.C.
6	Supply Voltage Input (Vs)

## Enable true table (optional)

HCMOS		
Pin 2	Pin 4	Pin 5
High	Data	N.C.
Open	Data	N.C.
Low	High Tristate	N.C.

## Marking

PX-504-xxxx
Frequency
● AYYWW

G 218

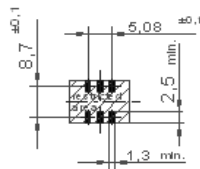
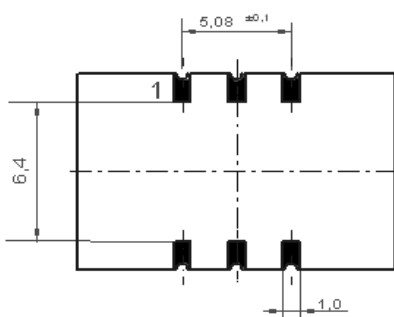
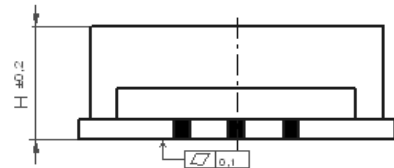
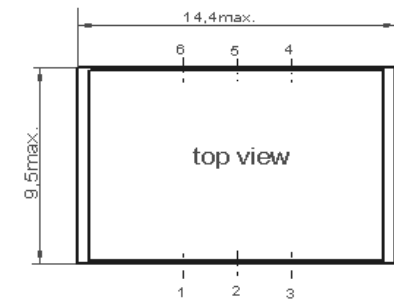

Padvorschlag  
land pattern  
recommendation

# Typical Performance

## Phase Noise

PX-504 @ 120 MHz LVCMOS

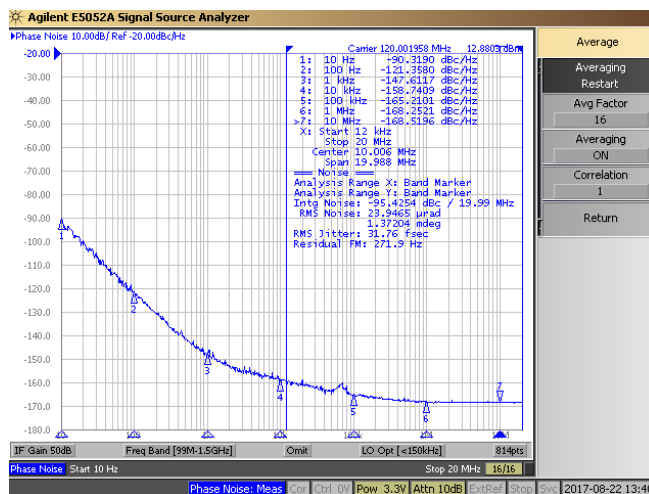

# Typical Performance

## G-Sensitivity

PX-504 @ 122.88 MHz LVCMOS

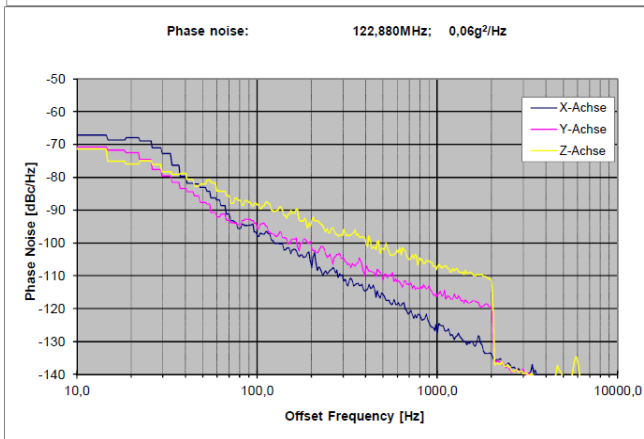
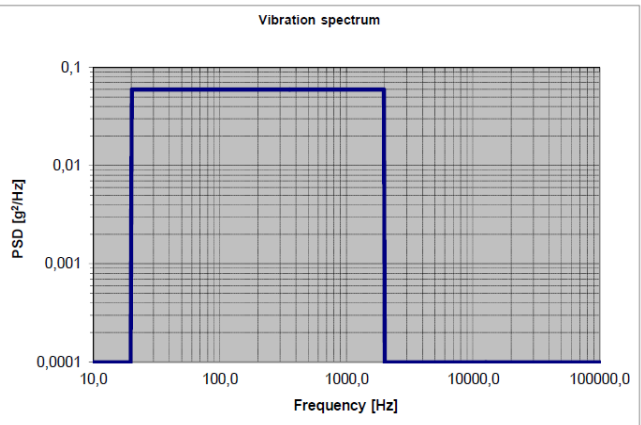
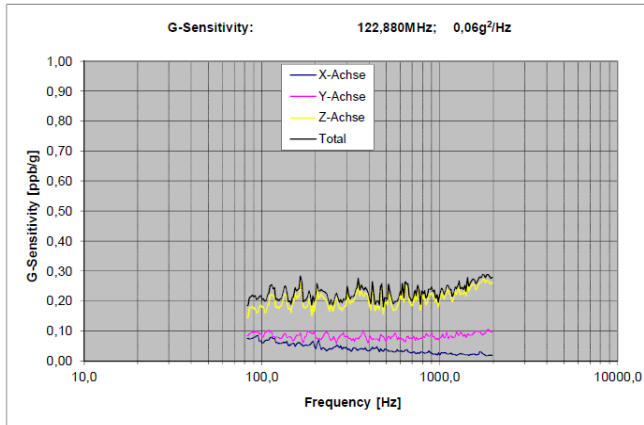

Calculation equation according to Vig-Tutorial

$$g\text{-sensitivity: } G = \frac{2 \cdot f_v}{A_{peak} \cdot f_0} \cdot 10^{\frac{L(f)}{20}}$$

$$\text{Peak g-level: } A_{peak} = \sqrt{PSD \cdot 2}$$

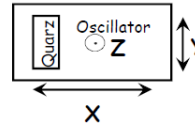

## Recommended Reflow Profile

TP: max 250°C (@ solder joint, customer board level)

T<sub>p</sub>: max: 10...30 sec

Additional Information:

This SMD oscillator has been designed for pick and place reflow soldering

SMD oscillators must be on the top side of the PCB during the reflow process.

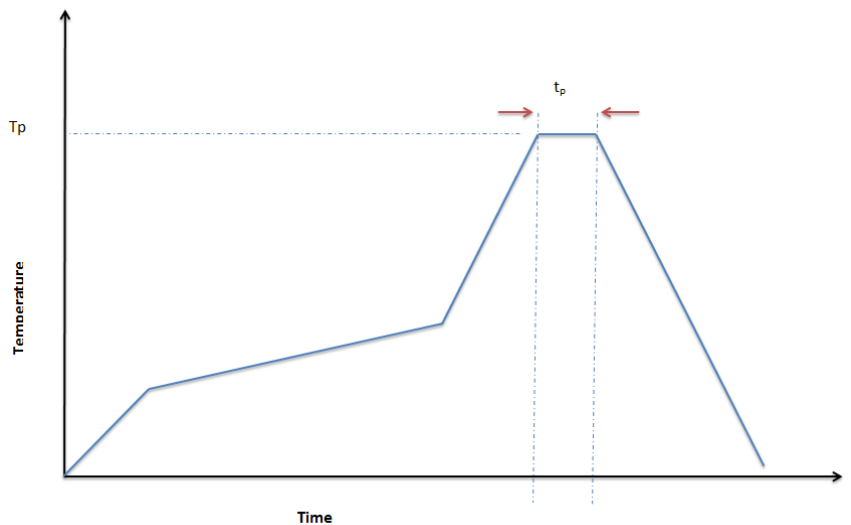

## Ordering Information

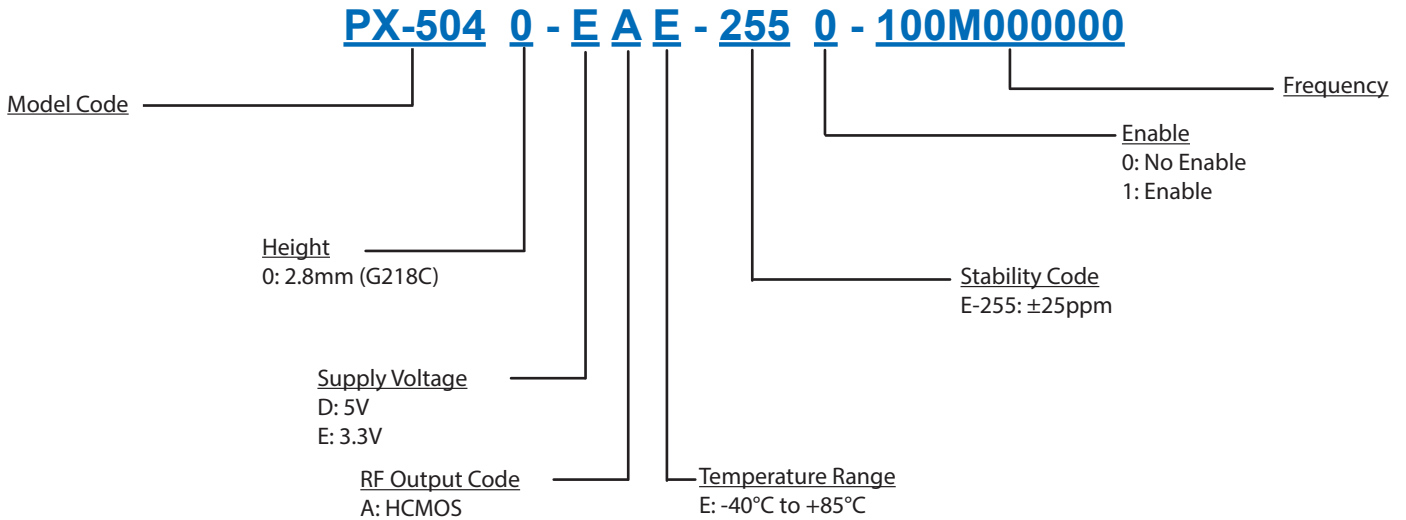

### Notes:

1. Contact factory for improved stabilities or additional product options. Not all options and codes are available at all frequencies.
2. Unless other stated all values are valid after warm-up time and refer to typical conditions for supply voltage, frequency control voltage, load, temperature (25°C).
3. Phase noise degrades with increasing output frequency.
4. Subject to technical modification.
5. Contact factory for availability.

## Contact Information

### USA:

100 Watts Street  
Mt Holly Springs, PA 17065  
Tel: 1.717.486.3411  
Fax: 1.717.486.5920

### Europe:

Landstrasse  
74924 Neckarbischofsheim  
Germany  
Tel: +49 (0) 7268.801.0  
Fax: +49 (0) 7268.801.281



Information contained in this publication regarding device applications and the like is provided only for your convenience and may be superseded by updates. It is your responsibility to ensure that your application meets with your specifications. MICROCHIP MAKES NO REPRESENTATION OR WARRANTIES OF ANY KIND WHETHER EXPRESS OR IMPLIED, WRITTEN OR ORAL, STATUTORY OR OTHERWISE, RELATED TO THE INFORMATION INCLUDING, BUT NOT LIMITED TO ITS CONDITION, QUALITY, PERFORMANCE, MERCHANTABILITY OR FITNESS FOR PURPOSE. Microchip disclaims all liability arising from this information and its use. Use of Microchip devices in life support and/or safety applications is entirely at the buyer's risk, and the buyer agrees to defend, indemnify and hold harmless Microchip from any and all damages, claims, suits, or expenses resulting from such use. No licenses are conveyed, implicitly, or otherwise, under any Microchip intellectual property rights unless otherwise stated.

### Trademarks

The Microchip and Vectron names and logos are registered trademarks of Microchip Technology Incorporated in the U.S.A. and other countries.

Rev. 31 May 2019