

Helping Customers Innovate, Improve & Grow



VX-990

### Features

- Ultra low Phase Noise
- Ultra low G-Sensitivity
- Vibration hardened
- Tight Tolerances
- Frequency Range           60 - 120MHz
- Standard Frequency       120MHz

### Applications

- Vibration Environment
- Airborne and Military Equipment
- Portable Equipment
- Radar

## Performance Specifications

Frequency Stabilities <sup>1</sup>						
Parameter	Min	Typical	Max	Units	Condition	Options <sup>3</sup>
vs. operating temperature range (referenced to nominal frequency)	-15.0		+15.0	ppm	-20 to +70°C	
	-25.0		+25.0	ppm	-40 to +85°C	
Initial tolerance	-15.0		+15.0	ppm	25°C V <sub>s</sub> ±5% static Load ±10% static after 30 days of operation after 30 days of operation	
vs. supply voltage change	-0.1		+0.1	ppm		
vs. load change	-0.1		+0.1	ppm		
vs. aging / 1 year	-1.0		+1.0	ppm		
vs. aging / 10 years	-3.0		+3.0	ppm		

## Performance Specifications

Supply Voltage (Vs)						
Parameter	Min	Typical	Max	Units	Condition	
Supply voltage (standard)	14.25	15	15.75	VDC		
Current consumption			100	mA		
RF Output						
Signal [standard]	Sinewave				50 Ω load	
Load	45	50	55	Ohm		
Output Power	10	13	16	dBm	50 Ω load	
Harmonics			-30	dBc	50 Ω load	
Spurious			-80	dBc	50 Ω load	
Frequency Tuning (EFC)						
Absolute Pulling Range	±0.0			ppm	Pulling range is sufficient to tune the oscillator over lifetime of 10 years and all circumstances to nominal frequency	
Tuning Slope	Positive					
Control Voltage Range	-4	0	+4	VDC		
Frequency control input impedance	50			kOhm		
Additional Parameters						
Phase Noise <sup>2</sup>		-90		dBc/Hz	10 Hz	@ 120 MHz 13 dBm sinewave no vibration
		-125		dBc/Hz	100 Hz	
		-153		dBc/Hz	1 kHz	
		-167		dBc/Hz	10 kHz	
		-173		dBc/Hz	100 kHz	
		-175		dBc/Hz	1 MHz	
G-Sensitivity		0.5		ppb/g	without shock absorbers <sup>3</sup>	
Weight		55	75	g		
Processing & Packing	Handling & Processing Note					
Additional Environmental Conditions						
Random Vibration	MIL-STD-202G; Method 214A; Cond H					
Shock	MIL-STD-202G; Method 213B; 15 g / 20 ms (for softest shock absorber i.e. lowest resonance frequency)					
Solderability	JEDEC J-STD-002: non RoHS compliant					
Solvent Resistance	non-washable device					
Absolute Maximum Ratings						
Supply voltage (Vs)			16.0	V		
Output Load	45		55	Ω		
Operable Temperature Range	-40		+85	°C		
Storage Temperature Range	-40		+105	°C		

## Outline Drawing / Enclosure

Parameter	Min	Typical	Max	Units	Condition
G295 including vibration isolators. Mechanical resonance frequency	35		110	Hz	Please specify vibration profile and phase noise max values under vibration

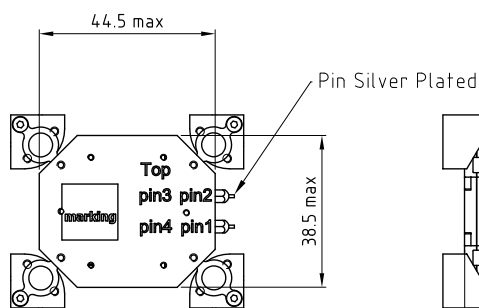
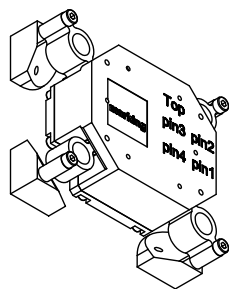
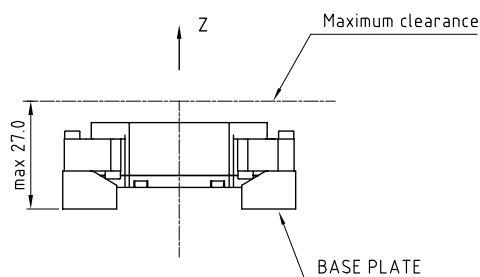

Dimensions in mm

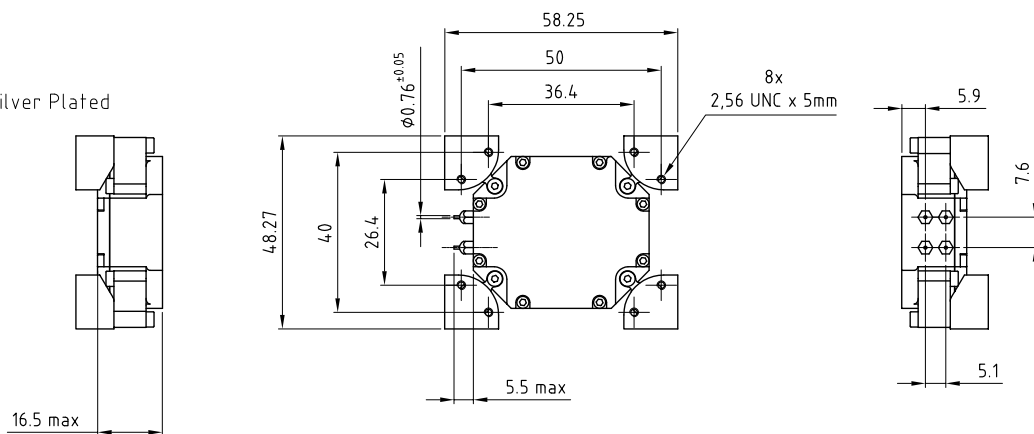

Pin Connections	
1	Control Voltage Input (Vc)
2	Supply Voltage (Vs)
3	RF-Output
4	Ground (Case)

## Housing Options

Parameter	Note
G295 Standard with vibration isolators	Option please specify vibration profile and phase noise max values under vibration
G313 without vibration isolators	Option please specify vibration profile and phase noise max values under vibration

**Note:** Customized housings are possible. Please specify housing and vibration profile and phase noise max values under vibration

## Typical Phase Noise @ 120 MHz without vibration

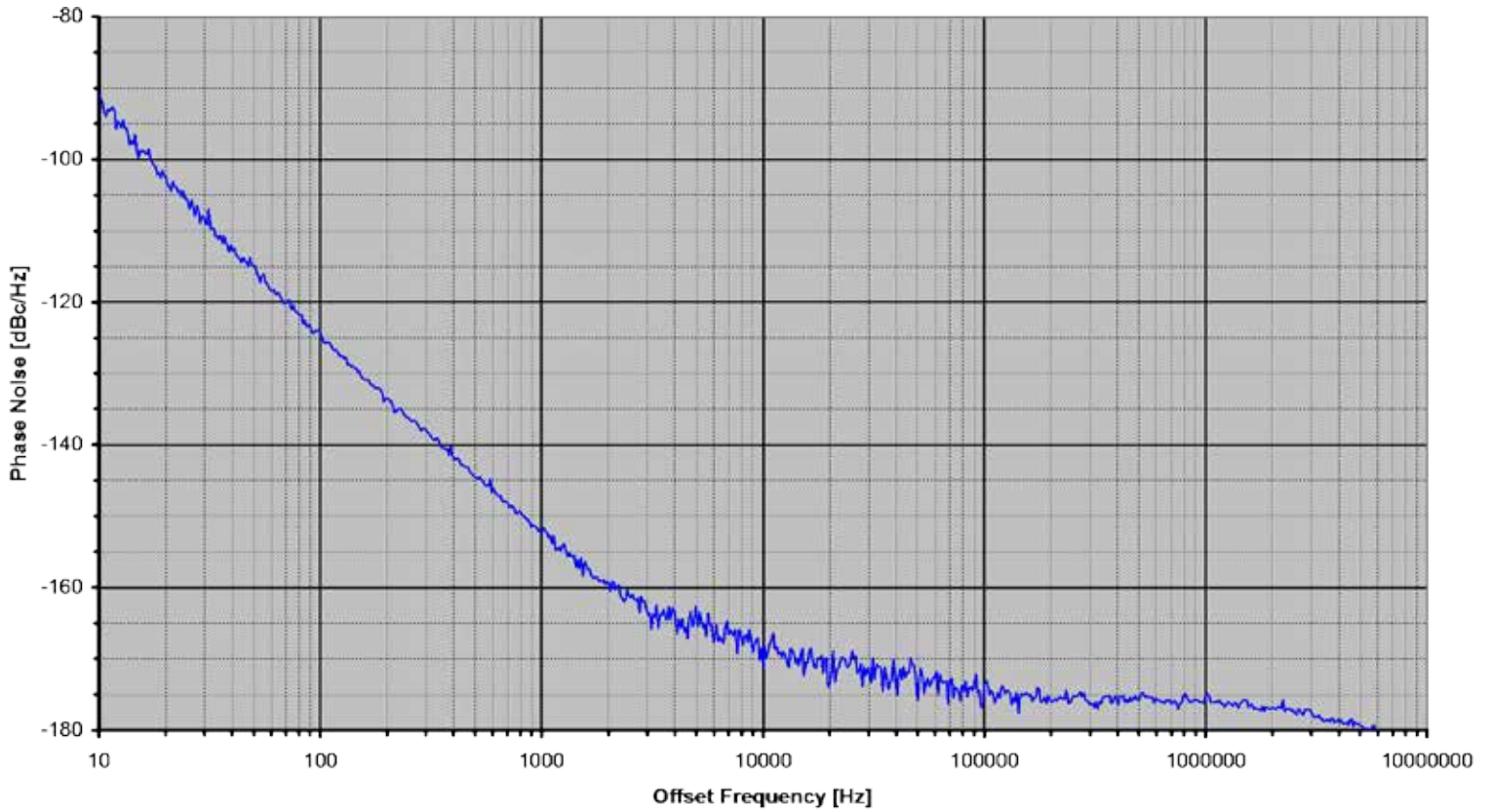

## Typical Frequency Stability vs Temperature

### Frequency vs. Temperature

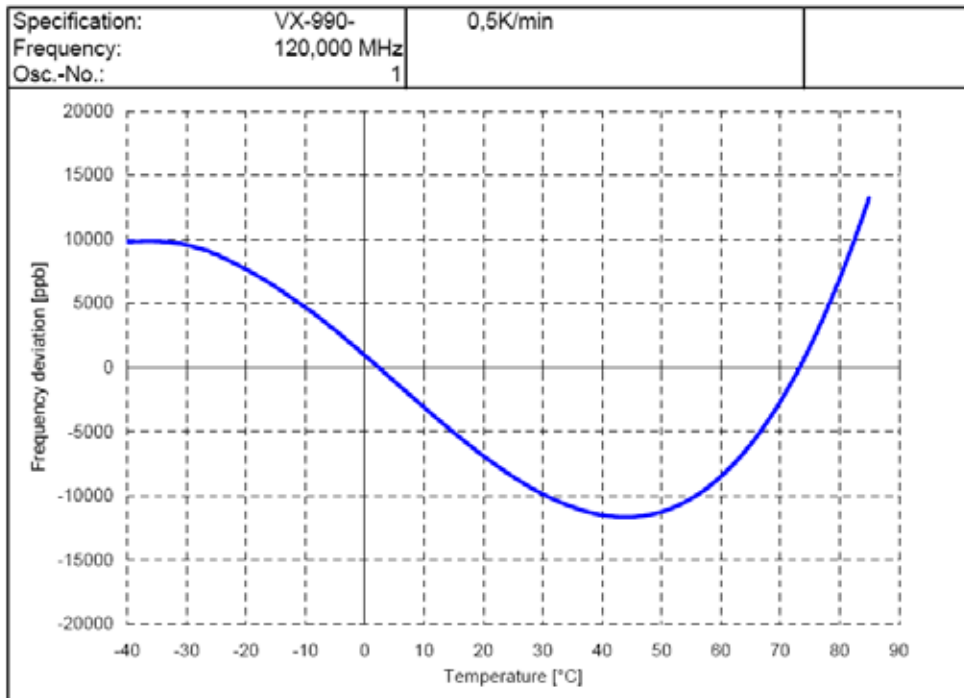

# Typical G-Sensitivity @120 MHz without shock absorber

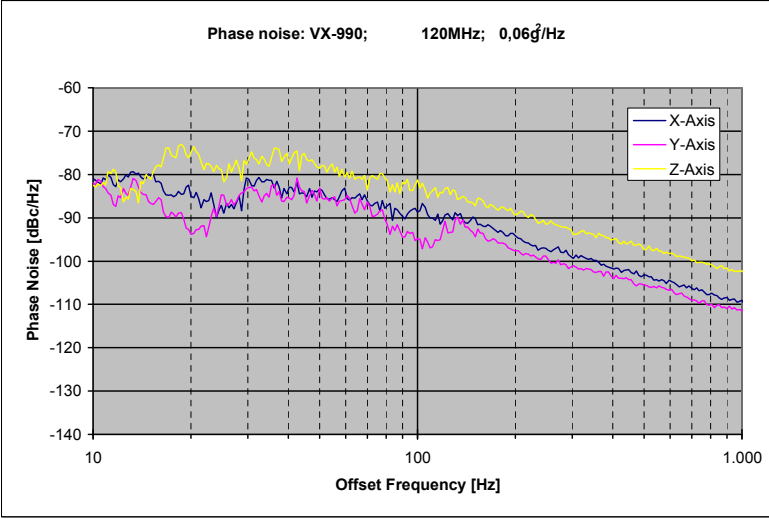
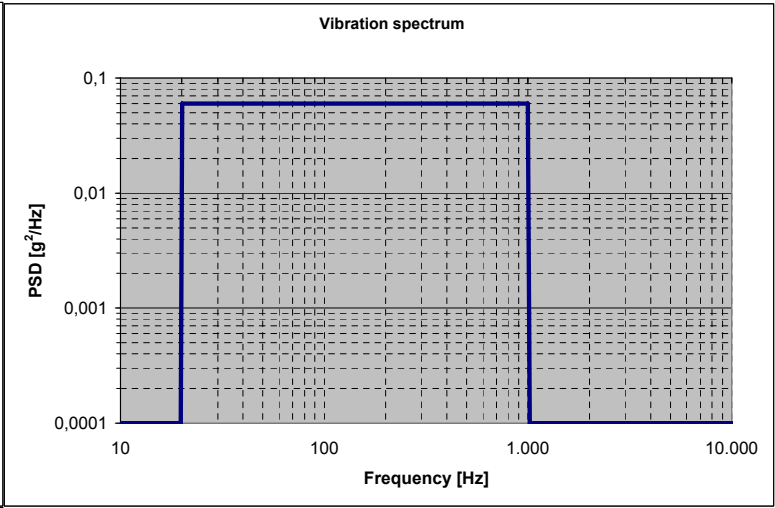
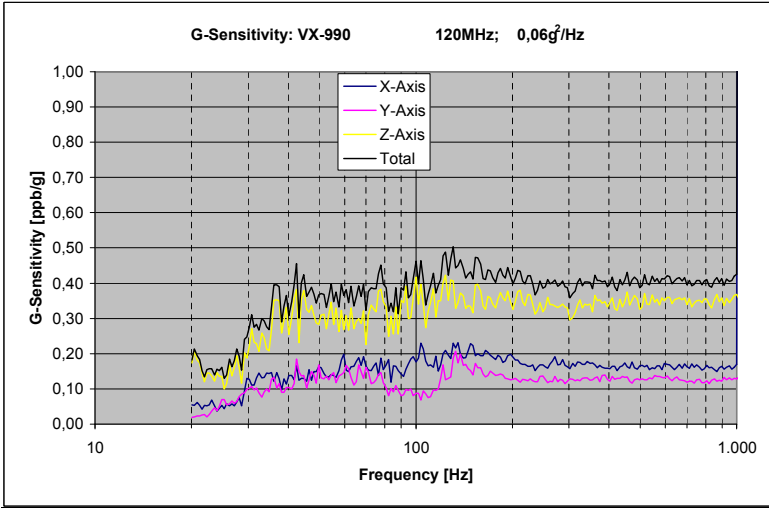

Calculation equation according to Vig-Tutorial

$$g\text{-sensitivity: } G = \frac{2 \cdot f_v}{A_{peak} \cdot f_0} \cdot 10^{\frac{L(f)}{20}}$$

$$Peak\ g\text{-level: } A_{peak} = \sqrt{PSD \cdot 2}$$

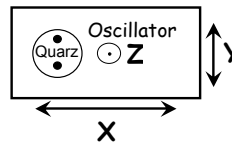

**Notes:**

1. Contact factory for improved stabilities or additional product options. Not all options and codes are available at all frequencies.
2. Phase noise degrades with increasing output frequency.
3. Contact factory for availability.

Unless other stated all values are valid after warm-up time and refer to typical conditions for supply voltage, frequency control voltage, load, temperature (25°C).

Subject to technical modification.

# Typical Phase Noise @ 120 MHz under vibration

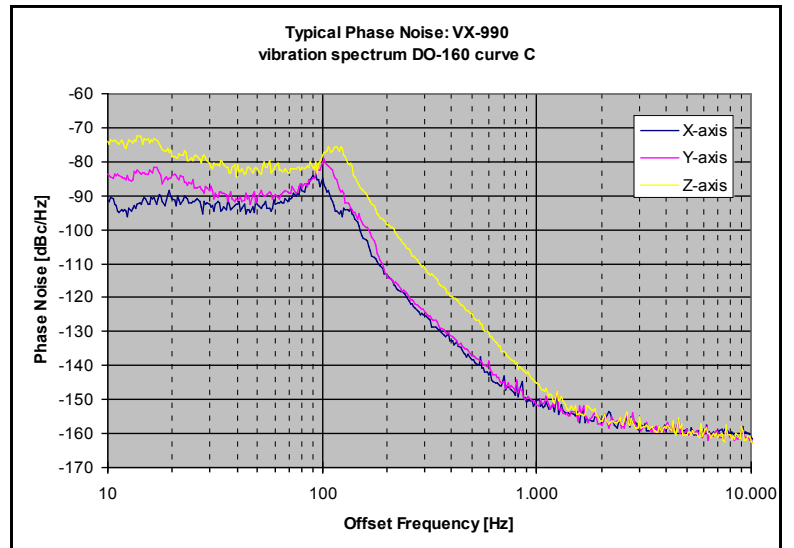
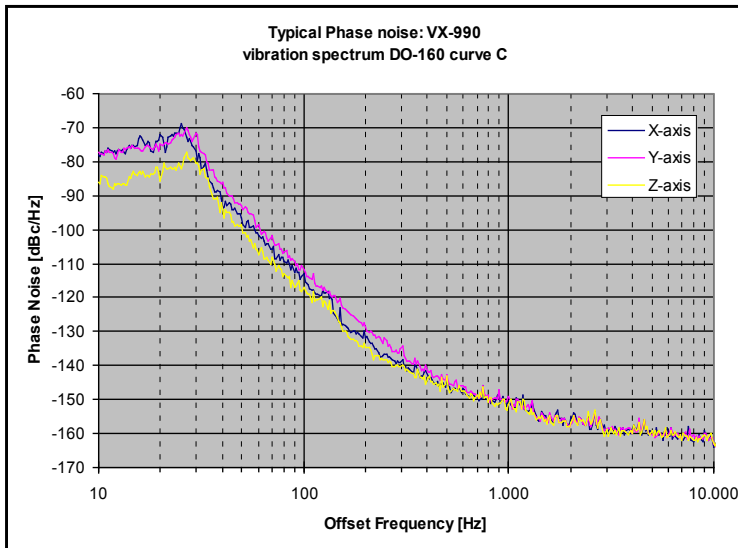
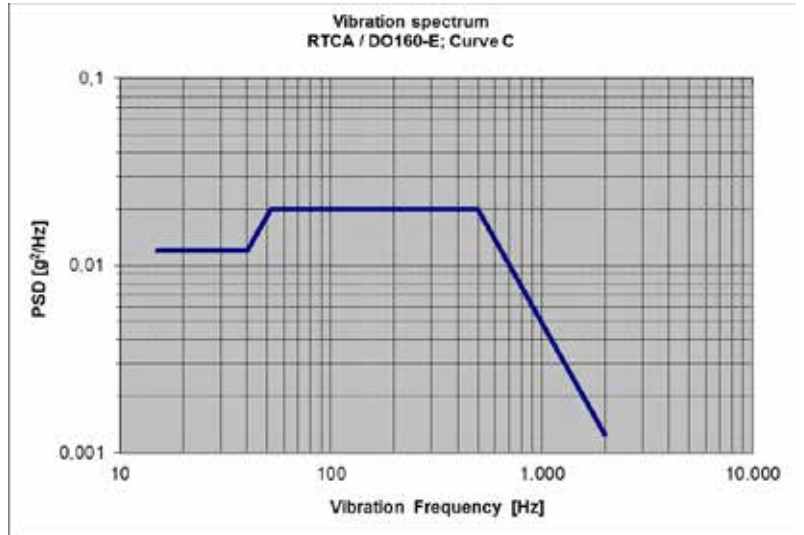
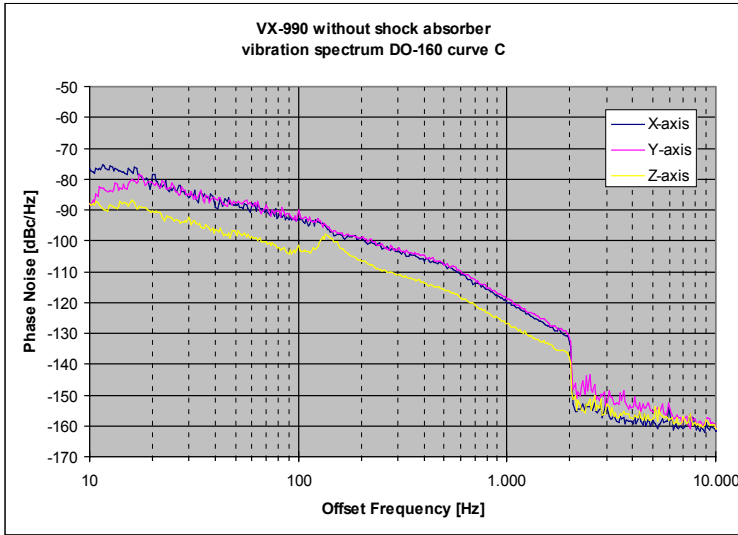

## Ordering Information

**All Oscillators from the 990s Product Group are Customized. Please include your complete specification, including vibration profile and required phase noise and phase noise under vibration to your inquiry.**

## Contact Information

### **USA:**

100 Watts Street  
Mt Holly Springs, PA 17065  
Tel: 1.717.486.3411  
Fax: 1.717.486.5920

### **Europe:**

Landstrasse  
74924 Neckarbischofsheim  
Germany  
Tel: +49 (0) 7268.801.0  
Fax: +49 (0) 7268.801.281



Information contained in this publication regarding device applications and the like is provided only for your convenience and may be superseded by updates. It is your responsibility to ensure that your application meets with your specifications. MICROCHIP MAKES NO REPRESENTATION OR WARRANTIES OF ANY KIND WHETHER EXPRESS OR IMPLIED, WRITTEN OR ORAL, STATUTORY OR OTHERWISE, RELATED TO THE INFORMATION INCLUDING, BUT NOT LIMITED TO ITS CONDITION, QUALITY, PERFORMANCE, MERCHANTABILITY OR FITNESS FOR PURPOSE. Microchip disclaims all liability arising from this information and its use. Use of Microchip devices in life support and/or safety applications is entirely at the buyer's risk, and the buyer agrees to defend, indemnify and hold harmless Microchip from any and all damages, claims, suits, or expenses resulting from such use. No licenses are conveyed, implicitly, or otherwise, under any Microchip intellectual property rights unless otherwise stated.

### **Trademarks**

The Microchip and Vectron names and logos are registered trademarks of Microchip Technology Incorporated in the U.S.A. and other countries.

Rev: 06/2019