



VS-508

Description

The VS-508 VCSO (Voltage Controlled Saw Oscillator) from Vectron is a high frequency, ultra low phase noise and low g-sensitivity oscillator designed to support harsh environmental applications. The VS-508 provides 12fs rms jitter in a 12kHz to 20MHz integration bandwidth and is available from 0.8 to 2.9GHz.

Features

- Frequency Range 0.8 to 2.9 GHz
- Ultra low jitter performance
- Typical Jitter: 12fsec rms, 12kHz to 20MHz
- G-Sensitivity <0.6ppb/g
- 3.3 + 5V supply voltage
- Output: Sinewave, balanced Sinewave, LVPECL
- 9x14 mm SMD package
- See table on Page 5 for standard frequencies

Applications

- Harsh Environment
- Military
- Test & Measurement

Performance Specifications

Pulling Characteristics					
Parameter	Min	Typ	Max	Units	Notes
Absolute Pull Range (APR)	±20			ppm	Includes df vs: •Operating temperature range +10 .. 85°C •Aging 10 years •Supply Voltage Change 5% •Load change 10%
Tuning Slope					Positive
Control Voltage Range	0.5	2.5	4.5	V DC	with $V_s = 5V$
	0	1.65	3.3	VDC	with $V_s = 3.3V$
Frequency control input impedance	20			k Ω	
Modulation bandwidth	100			kHz	@ -3dB
Supply Voltage (V_s)					
Supply voltage (standard)	4.75	5.00	5.25	V DC	
Current consumption			65	mA	
Supply voltage (standard)	3.135	3.3	3.465	V DC	
Current consumption			100	mA	

Performance Specifications (Continued)

RF Output					
Parameter	Min	Typ	Max	Units	Notes
Signal	LVPECL				
Load	45	50	55	Ω	
Duty Cycle	45		55	%	
Phase Noise: 100Hz offset		-78		dBc/Hz	@ 1GHz LVPECL 3.3V
Phase Noise: 1kHz offset		-102		dBc/Hz	
Phase Noise: 10kHz offset		-129		dBc/Hz	
Phase Noise: 100kHz offset		-148		dBc/Hz	
Phase Noise: 1MHz offset		-150		dBc/Hz	
Phase Noise: 10MHz offset		-150		dBc/Hz	
Jitter: 12kHz to 20MHz offset		29		fs rms	
Signal	Balanced Sinewave				
Load	45	50	55	Ω	
Output Power	0	3	6	dBm	
Phase Noise: 100Hz offset		-65		dBc/Hz	@ 2GHz Sinewave 3.3V
Phase Noise: 1kHz offset		-95		dBc/Hz	
Phase Noise: 10kHz offset		-120		dBc/Hz	
Phase Noise: 100kHz offset		-141		dBc/Hz	
Phase Noise: 1MHz offset		-154		dBc/Hz	
Phase Noise: 10MHz offset		-165		dBc/Hz	
Jitter: 12kHz to 20MHz offset		10		fs rms	

Additional Parameters					
Parameter	Min		Max	Units	Notes
Weight	2.0g				
Subharmonics			-30 -20	dBc dBc	< 2 GHz > 2 GHz
G-Sensitivity		0.6		ppb/g	
Processing and Packing	Handling and Processing Note				
Absolute Maximum Ratings					
Parameter	Min		Max	Units	Notes
Supply Voltage (V_s)			6.0	V	
Operable Temperature Range	-40		+85	$^{\circ}$ C	
Storage Temperature Range	-40		+95	$^{\circ}$ C	

Typical Performance

Phase Noise

VS-508 @ 1GHz LVPECL

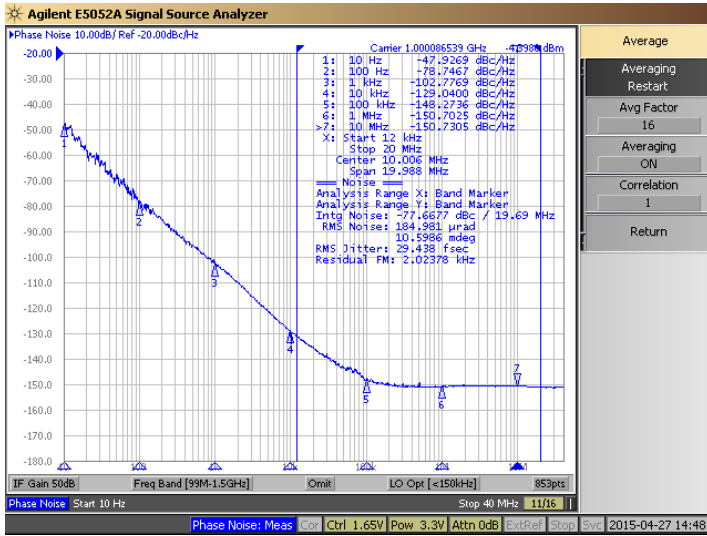

Phase Noise

VS-508 @ 2GHz Sinewave

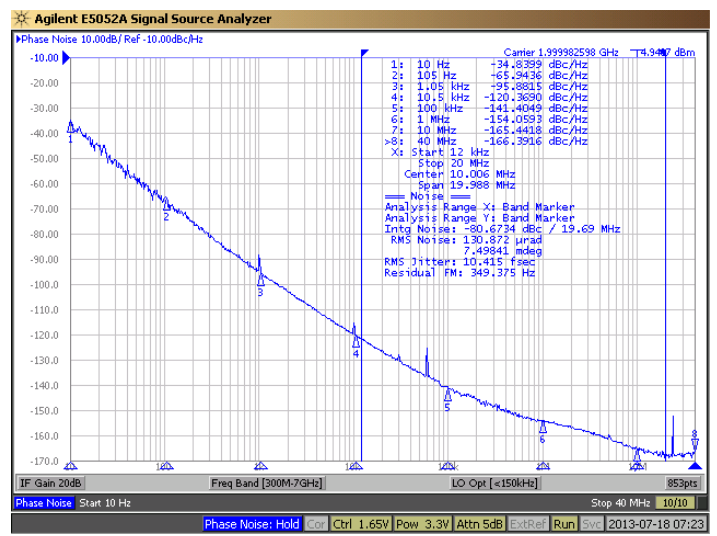

G-Sensitivity

VS-508 @ 1GHz LVPECL

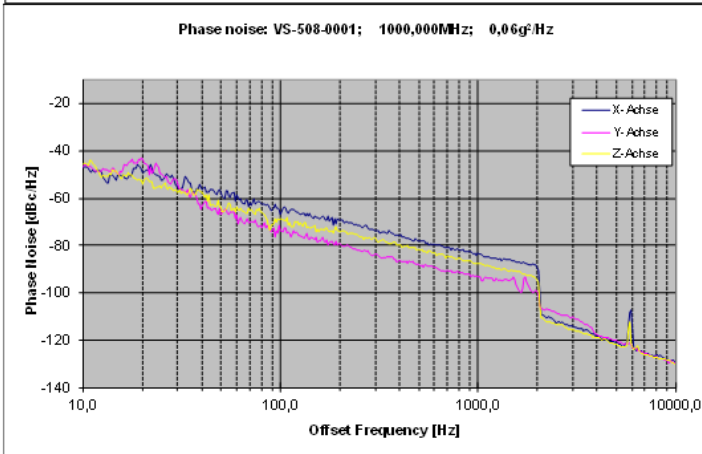
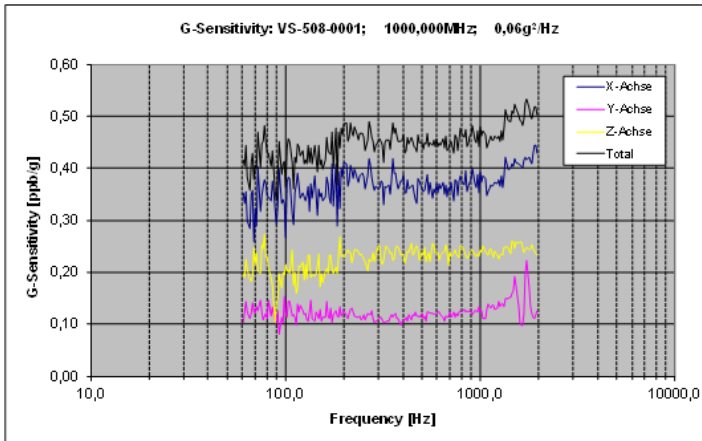

Vibration spectrum

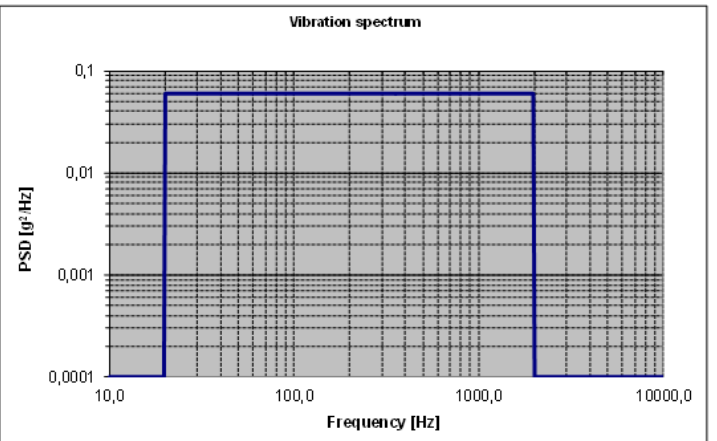

Calculation equation according to Vig-Tutorial

$$g\text{-sensitivity: } G = \frac{2 \cdot f_0}{A_{peak} \cdot f_0} \cdot 10^{\frac{L(\hat{A})}{20}}$$

$$Peak\text{-level: } A_{peak} = \sqrt{PSD \cdot 2}$$

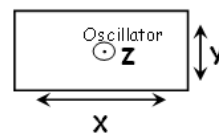

Comments:

Outline Drawing / Enclosure

Package Codes		
Code	Height "H"	Pin Length "L"
G347	4.9	N/A

Dimensions in mm

G347

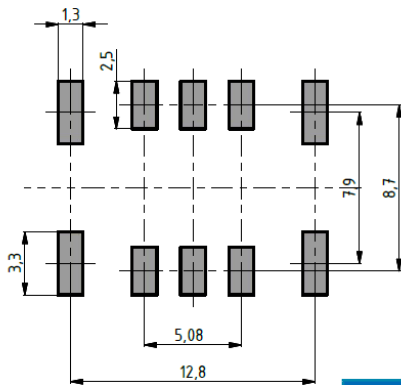
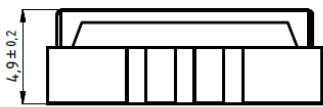
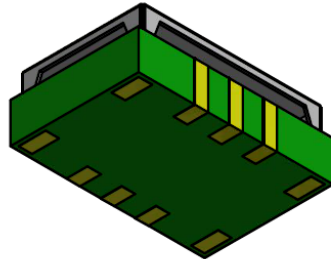
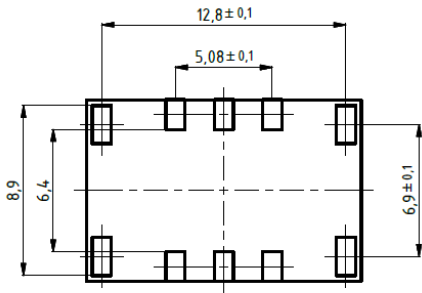

Padvorschlag
land pattern
recommendation

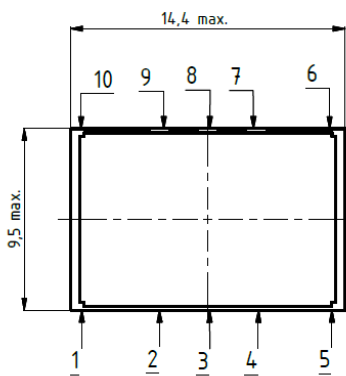

Pin Assignment Sinewave	
1	GND
2	Control Voltage (V_c)
3	N.C. (Not Connected)
4	GND
5	GND
6	GND
7	RF Out
8	N.C. (Not Connected)
9	Supply Voltage Input (V_s)
10	GND

Pin Assignment LVPECL	
1	GND
2	Control Voltage (V_c)
3	N.C. (Not Connected)
4	GND
5	GND
6	GND
7	RF Out
8	RF-Out_complementary
9	Supply Voltage Input (V_s)
10	GND

Pin Assignment Balanced Sinewave	
1	GND
2	Control Voltage (V_c)
3	N.C. (Not Connected)
4	GND
5	GND
6	GND
7	RF Out
8	RF-Out_Compl. 180° phase shifted
9	Supply Voltage Input (V_s)
10	GND

Marking	
VS-508-xxxx	
Frequency	
•AYYWW	

Standard Shipping Method

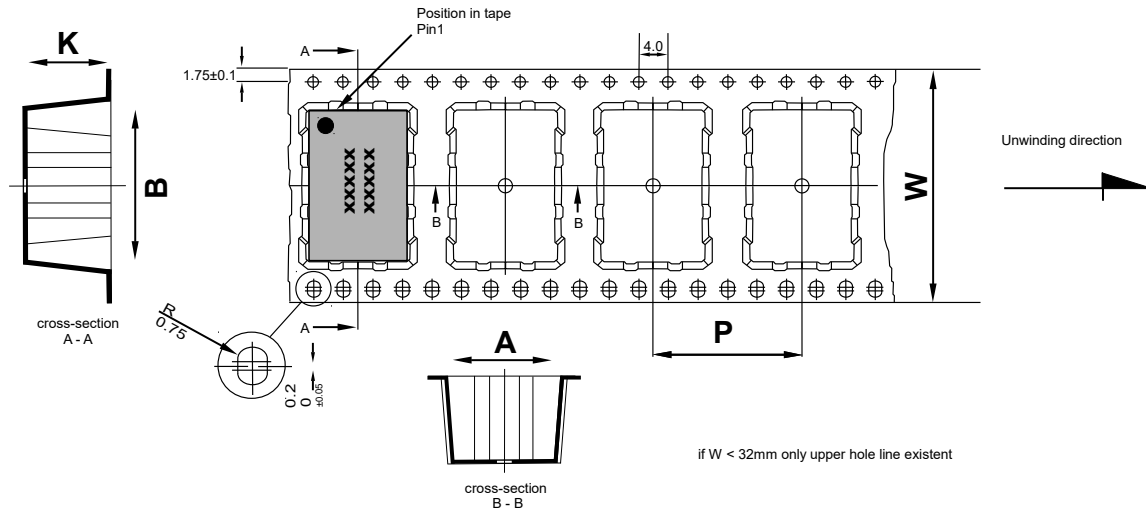

Dimension in mm:

A, B and K are dependent upon component dimensions
production tolerance complying DIN IEC 286-3

All dimensions in millimeters unless otherwise stated

Enclosure Type	Tape Width W (mm)	Quantity per meter	Quantity per reel	Dimension P (mm)
G347	24		850	12

Recommended Reflow Profile

TP: max 250°C (@ solder joint, customer board level)

T_p: max: 10...30 sec

Additional Information:

This SMD oscillator has been designed for pick and place reflow soldering

SMD oscillators must be on the top side of the PCB during the reflow process.

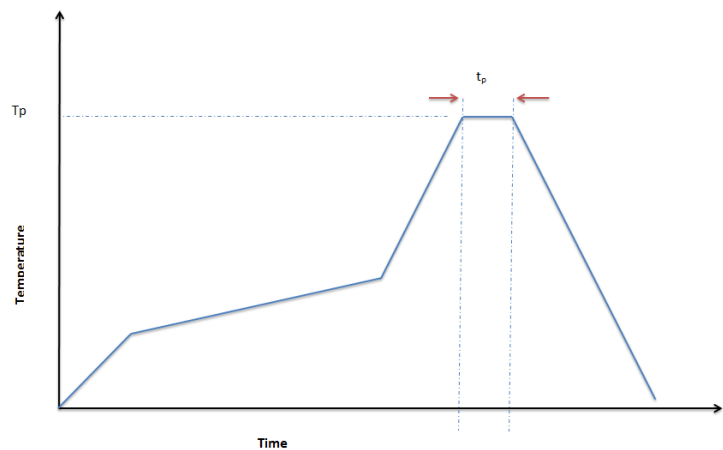

Ordering Information

VS - 508 0 - E E X - 205 X - 2000M0

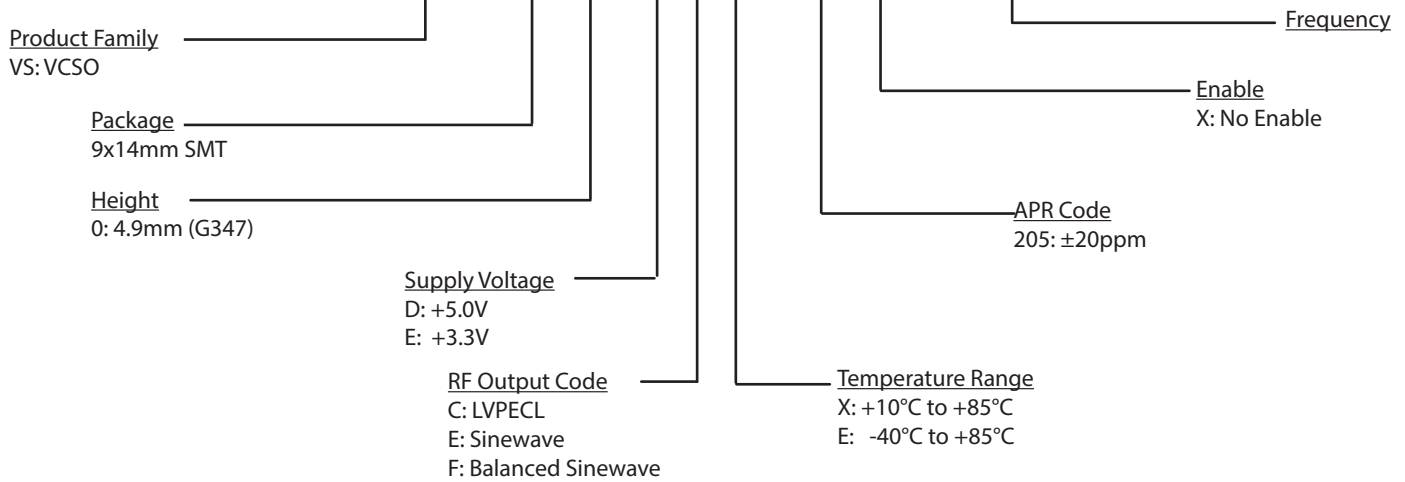

Standard Frequencies (MHz)

632.8125	784.489605	832	867.1875	873.5154185	949.976022	980.604559
993.4096915	1000	1024.23965	1034.337568	1040	1067.686799	1200
1265.625	1280	1568.97921	1687.5	1701.32	1707.08	1734.375
1747.030837	1747.62305	1748.366885	1769.145	1875	1879.437686	1884.052863
1899.952044	1961.209118	1968.75	1986.819383	2000	2048.4793	2068.675135
2104.658326	2135.373597	2187.5	2400	2457.6	2560	2812.5
2949.12						

Other Frequencies Available Upon Request

Notes:

- Contact factory for improved stabilities or additional product options. Not all options and codes are available at all frequencies.
- Unless other stated all values are valid after warm-up time and refer to typical conditions for supply voltage, frequency control voltage, load, temperature (25°C).
- Phase noise degrades with increasing output frequency.
- Subject to technical modification.
- Contact factory for availability.

Contact Information

USA:

100 Watts Street
Mt Holly Springs, PA 17065
Tel: 1.717.486.3411
Fax: 1.717.486.5920

Europe:

Landstrasse
74924 Neckarbischofsheim
Germany
Tel: +49 (0) 7268.801.0
Fax: +49 (0) 7268.801.281



Information contained in this publication regarding device applications and the like is provided only for your convenience and may be superseded by updates. It is your responsibility to ensure that your application meets with your specifications. MICROCHIP MAKES NO REPRESENTATION OR WARRANTIES OF ANY KIND WHETHER EXPRESS OR IMPLIED, WRITTEN OR ORAL, STATUTORY OR OTHERWISE, RELATED TO THE INFORMATION INCLUDING, BUT NOT LIMITED TO ITS CONDITION, QUALITY, PERFORMANCE, MERCHANTABILITY OR FITNESS FOR PURPOSE. Microchip disclaims all liability arising from this information and its use. Use of Microchip devices in life support and/or safety applications is entirely at the buyer's risk, and the buyer agrees to defend, indemnify and hold harmless Microchip from any and all damages, claims, suits, or expenses resulting from such use. No licenses are conveyed, implicitly, or otherwise, under any Microchip intellectual property rights unless otherwise stated.

Trademarks

The Microchip and Vectron names and logos are registered trademarks of Microchip Technology Incorporated in the U.S.A. and other countries.